

# GaAlAs Parallel Beam Infrared LED

# KED050HV

### Features

- Parallel beam
- 50 μm dia. emitting area
- Uniform light intensity distribution

### Applications

- Optical encoders
- Linear encoders
- Reflective sensors

### Dimensions (unit: mm)

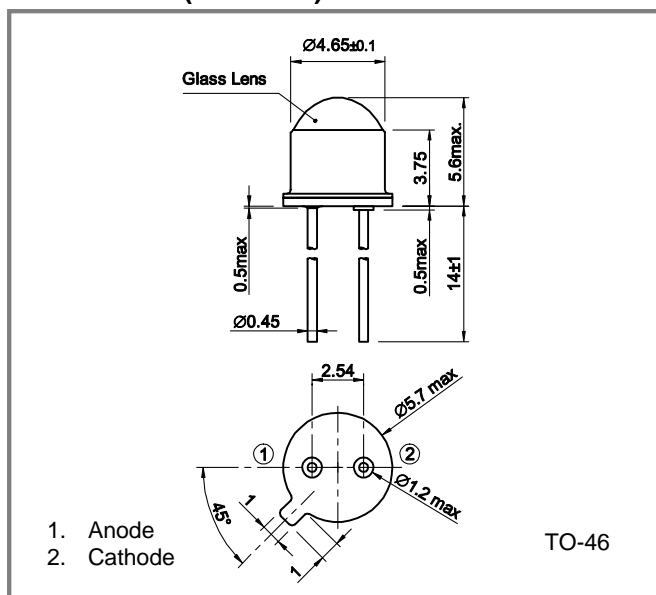

### Absolute Maximum Ratings

Parameter	Symbol	Value	Unit	Note
Forward current	$I_F$	80	mA	$T_a=25^\circ\text{C}$
Reverse voltage	$V_R$	3	V	
Power dissipation	$P_D$	150	mW	
Operating temperature	$T_{opr}$	-20 to +100	$^\circ\text{C}$	Avoid dew condensation
Storage temperature	$T_{stg}$	-30 to +100	$^\circ\text{C}$	Avoid dew condensation

### Electrical and Optical Characteristics ( $T_a=25^\circ\text{C}$ unless otherwise noted)

Parameter	Symbol	Min.	Typ.	Max	Unit	Test Conditions
Forward Voltage	$V_F$	-	1.9	2.4	V	$I_F=50\text{mA}$
Reverse Current	$I_R$	-	-	10	$\mu\text{A}$	$V_R=3\text{V}$
Optical Output Power	$P_o$	-	2.0	-	mW	$I_F=50\text{mA}$
Peak emission wavelength	$\lambda_P$	-	850	-	nm	$I_F=50\text{mA}$
Spectral bandwidth at 50%	$\Delta\lambda$	-	50	-	nm	$I_F=50\text{mA}$

Specifications are subject to change without notice.

# GaAlAs Parallel Beam Infrared LED

# KED050HV

**Allowable Forward Current - Ambient Temperature**

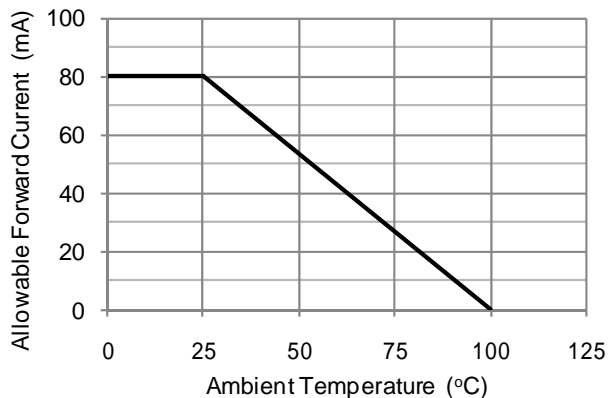

**Optical Output Power-Forward Current**

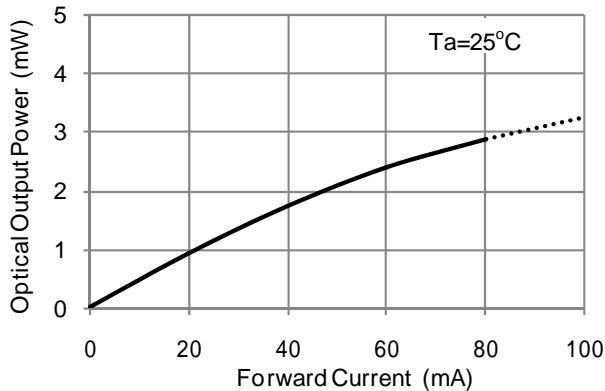

**Forward Current - Forward Voltage**

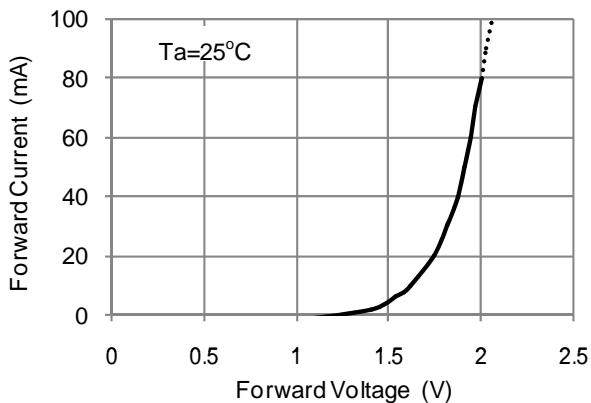

**Relative Optical Output Power-Ambient Temperature**

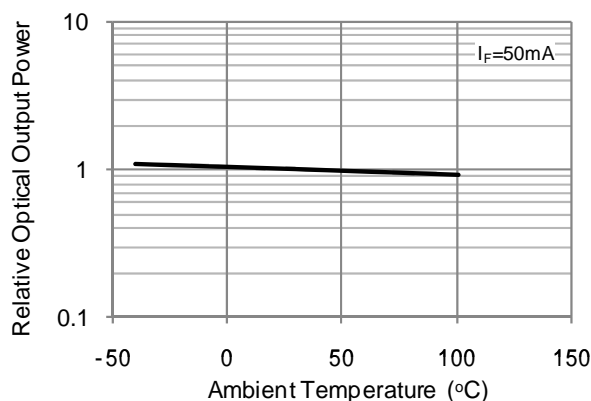

**Spectral Distribution**

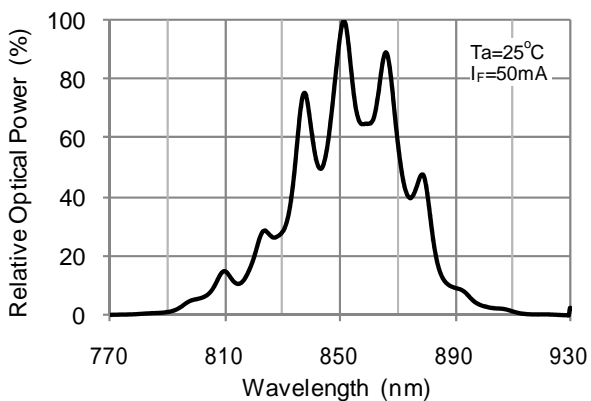

**Directivity**

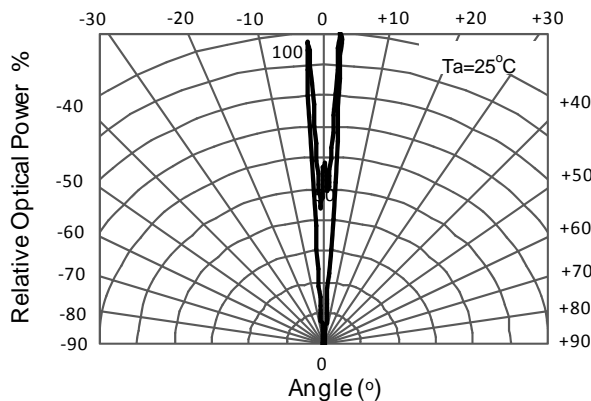

**Beam parallelism**

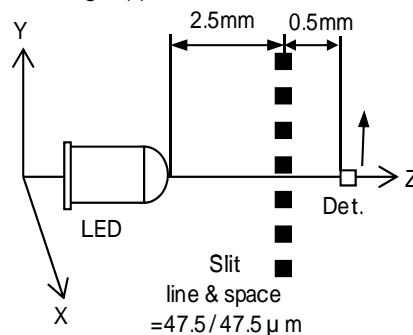
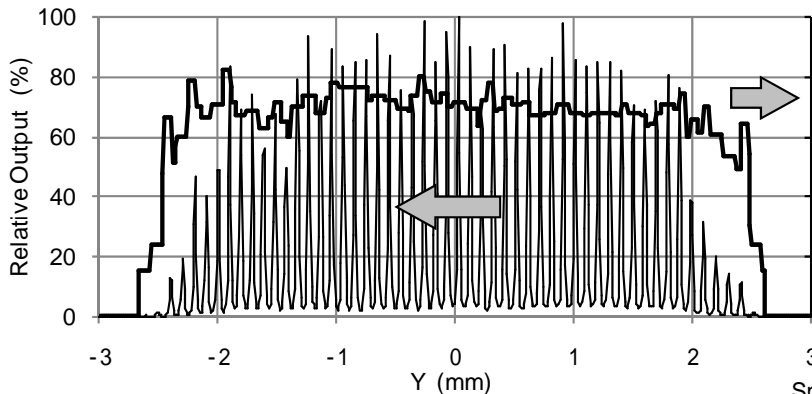

$$S/N = 10 \log(P_{max}/P_{min})$$

Specifications are subject to change without notice.

**Contacts:**

[www.kyosemi.co.jp](http://www.kyosemi.co.jp) / [info@kyosemi.co.jp](mailto:info@kyosemi.co.jp)

Kansai Sales Office: 949-2 Ebisu-cho, Fushimi-ku, Kyoto, 612-8201 Japan Tel: +81 75 605 7311 Fax: +81 75 605 7312 (Overseas Sales Dept.)

Tokyo Sales Office: 24th Sky Building, 2nd Floor, 1-34-3 Shinjuku, Shinjuku-ku, Tokyo 160-0022 Japan Tel: +81 3 5312 5360 Fax: +81 3 5312 5367

Eniwa Operation: 385-31 Toiso, Eniwa-shi, Hokkaido 061-1405 Japan Tel: +81 123 34 3111 Fax: +81 123 34 2110

Kyosemi Opto America Corp: 3003 Bunker Hill Lane, Suite 102, Santa Clara, CA 95054 USA Tel: +1 408 492 1486 Fax: +1 408 492 9843