

Point-source Red LED

KED080RAXH

Features

- High reliability and long life
- 80µm emitting area

Applications

- High speed optical sensors
- Optical Encoders

Dimensions (unit: mm)

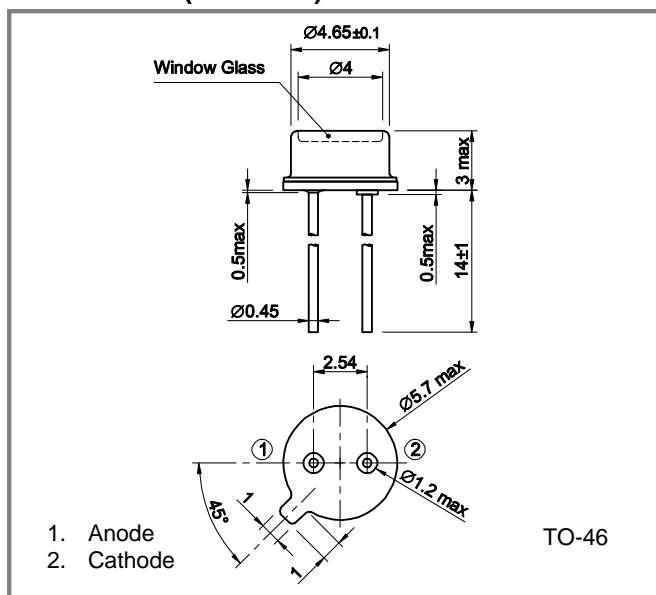

Absolute Maximum Ratings

Parameter	Symbol	Value	Unit	Note
Forward current	I_F	25	mA	
Reverse voltage	V_R	3	V	
Operating temperature	T_{opr}	-20 to +80	°C	Avoid dew condensation
Storage temperature	T_{stg}	-30 to +100	°C	Avoid dew condensation

Electrical and Optical Characteristics (Ta=25 °C unless otherwise noted)

Parameter	Symbol	Min.	Typ.	Max	Unit	Test Conditions
Forward voltage	V_F	-	2.2	3.0	V	$I_F=20\text{mA}$
Reverse current	I_R	-	-	10	µA	$V_R=3\text{V}$
Optical output power	P_o	-	0.6	-	mW	$I_F=20\text{mA}$
Peak emission wavelength	λ_P	-	650	-	nm	$I_F=20\text{mA}$
Cutoff frequency	f_c	-	70	-	MHz	$I_F=20\text{mA}$

Specifications are subject to change without notice.

Point-source Red LED

KED080RAXH

Allowable Forward Current - Ambient Temperature

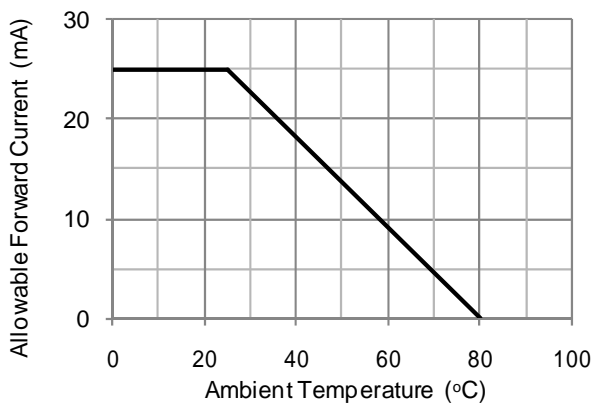

Optical Output Power - Forward Current

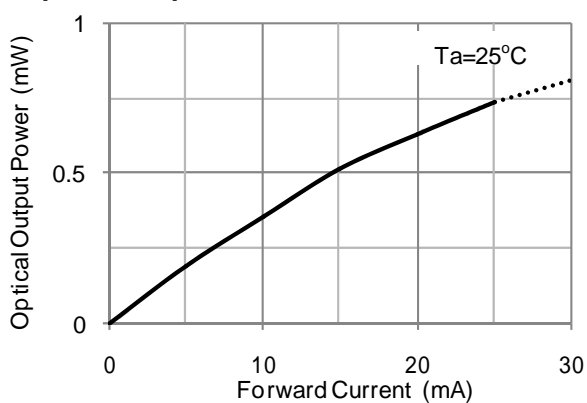

Forward Current - Forward Voltage

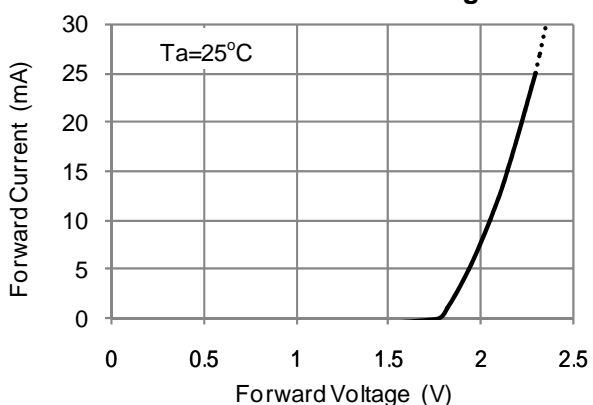

Relative Optical Output Power - Ambient Temperature

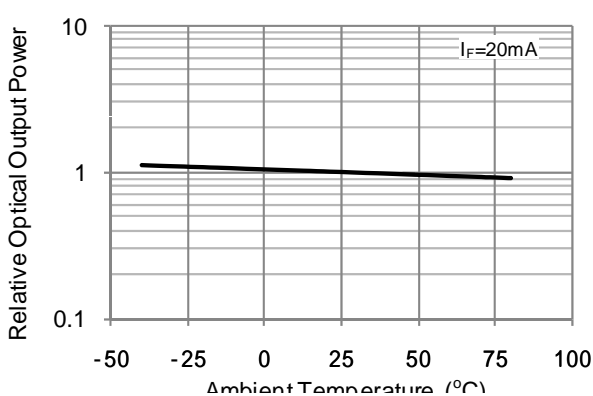

Spectral Distribution

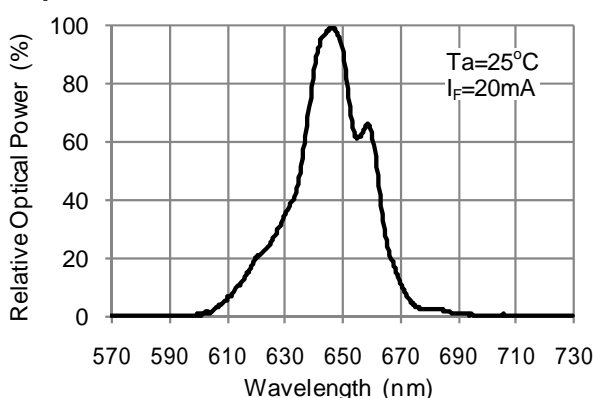

Directivity

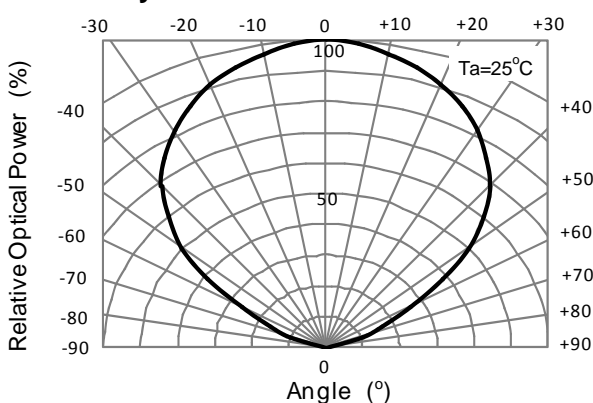

Frequency Response

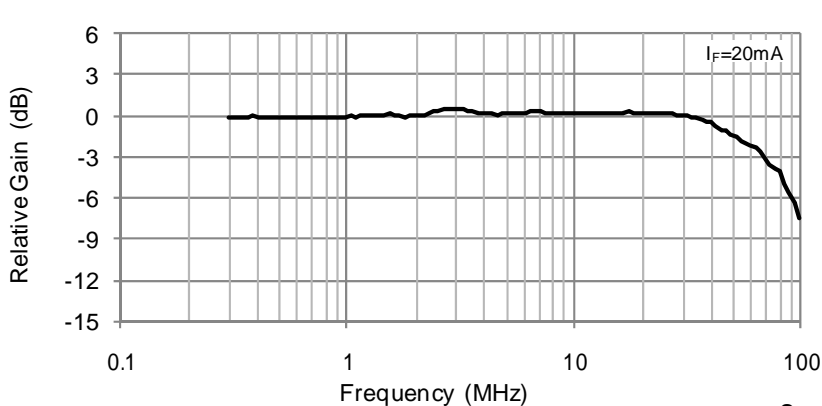

Specifications are subject to change without notice.

Contacts:

www.kyosemi.co.jp / info@kyosemi.co.jp

Kansai Sales Office: 949-2 Ebisu-cho, Fushimi-ku, Kyoto, 612-8201 Japan Tel: +81 75 605 7311 Fax: +81 75 605 7312 (Overseas Sales Dept.)

Tokyo Sales Office: 24th Sky Building, 2nd Floor, 1-34-3 Shinjuku, Shinjuku-ku, Tokyo 160-0022 Japan Tel: +81 3 5312 5360 Fax: +81 3 5312 5367

Eniwa Operation: 385-31 Toiso, Eniwa-shi, Hokkaido 061-1405 Japan Tel: +81 123 34 3111 Fax: +81 123 34 2110

Kyosemi Opto America Corp: 3003 Bunker Hill Lane, Suite 102, Santa Clara, CA 95054 USA Tel: +1 408 492 1486 Fax: +1 408 492 9843