

GaAlAs Parallel Beam Infrared LED

KED308HV

Features

- Parallel beam
- High output power
- Uniform light intensity distribution

Applications

- Optical encoders
- Linear encoders
- Reflective sensors

Dimensions (unit: mm)

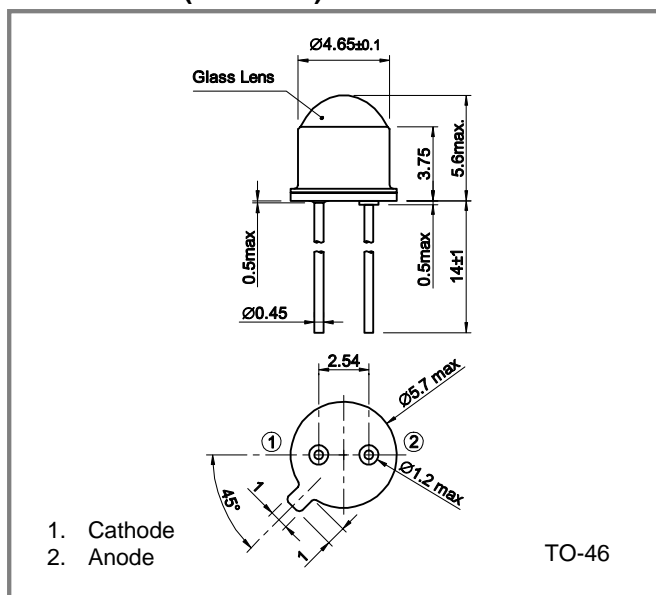

Absolute Maximum Ratings

Parameter	Symbol	Value	Unit	Note
Forward current	I_F	80	mA	$T_a=25^\circ\text{C}$
Reverse voltage	V_R	5	V	
Power dissipation	P_D	140	mW	
Operating temperature	T_{opr}	-40 to +125	$^\circ\text{C}$	Avoid dew condensation
Storage temperature	T_{stg}	-40 to +125	$^\circ\text{C}$	Avoid dew condensation

Electrical and Optical Characteristics ($T_a=25^\circ\text{C}$ unless otherwise noted)

Parameter	Symbol	Min.	Typ.	Max	Unit	Test Conditions
Forward voltage	V_F	-	1.6	2.0	V	$I_F=50\text{mA}$
Reverse current	I_R	-	-	10	μA	$V_R=5\text{V}$
Optical output power	P_o	-	7	-	mW	$I_F=50\text{mA}$
Peak emission wavelength	λ_P	-	870	-	nm	$I_F=50\text{mA}$
Spectral bandwidth at 50%	$\Delta\lambda$	-	50	-	nm	$I_F=50\text{mA}$

Specifications are subject to change without notice.

GaAlAs Parallel Beam Infrared LED

KED308HV

Allowable Forward Current - Ambient Temperature

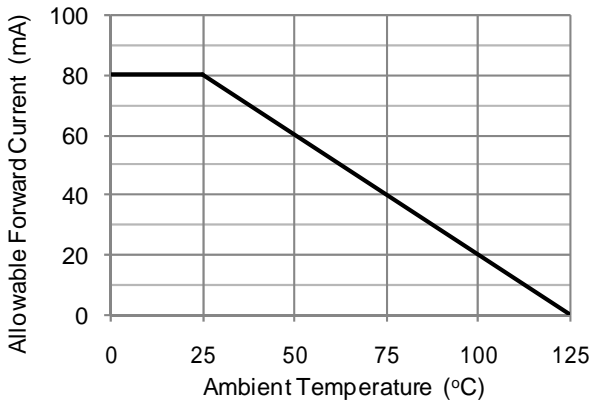

Optical Output Power - Forward Current

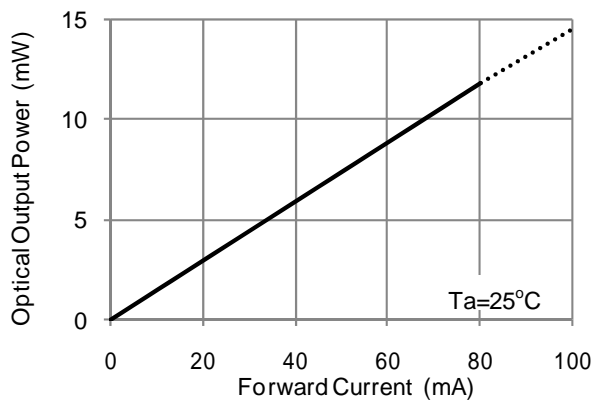

Forward Current - Forward Voltage

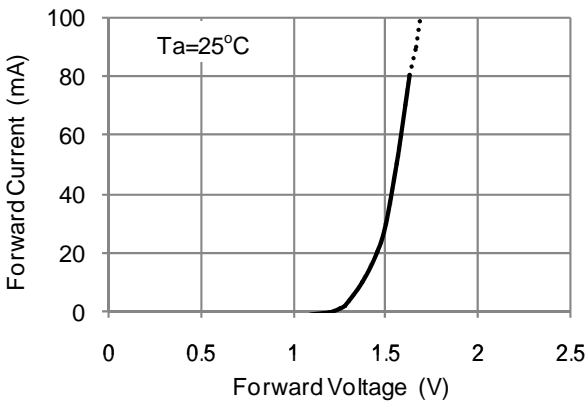

Relative Optical Output Power - Ambient Temperature

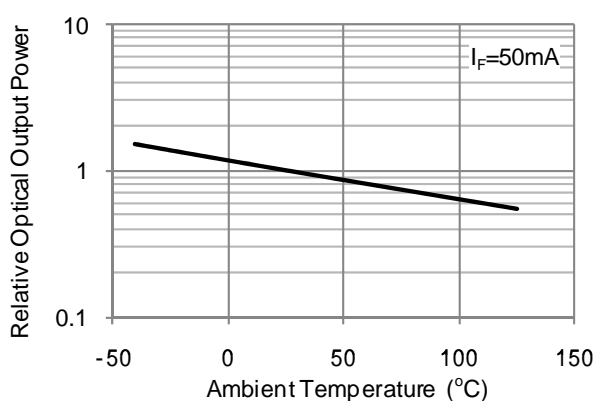

Spectral Distribution

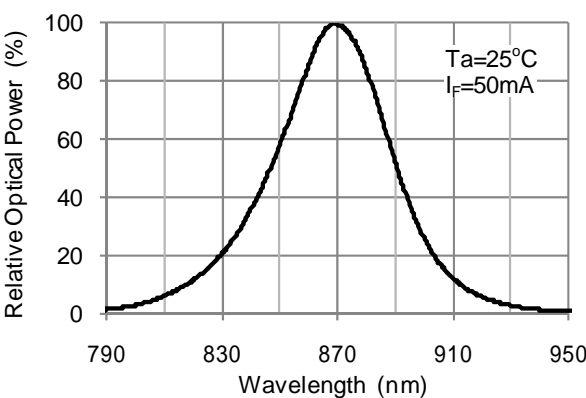

Directivity

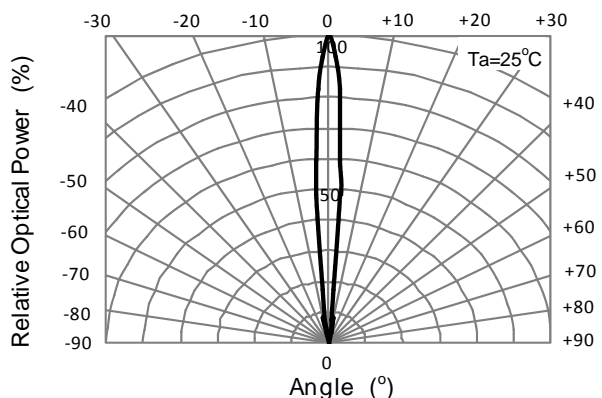

Beam parallelism

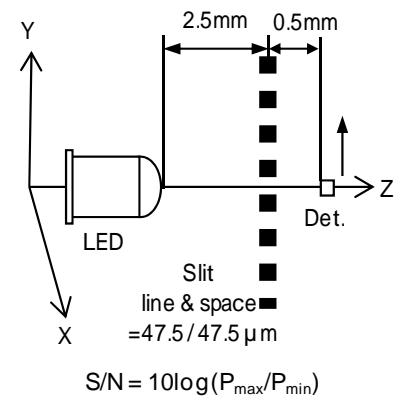
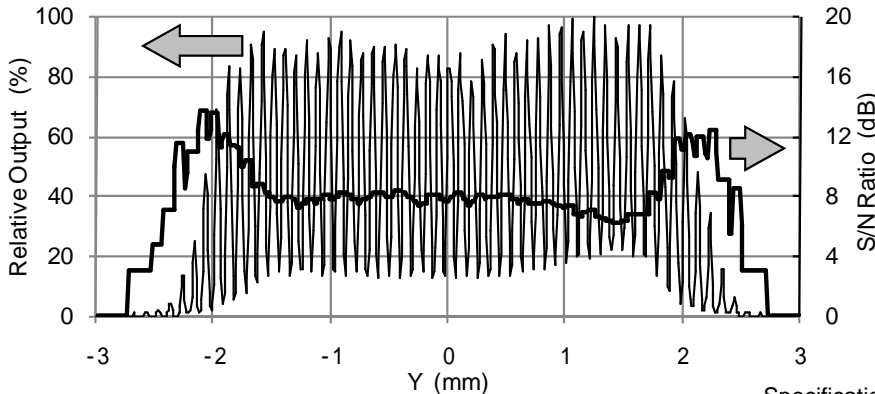

Specifications are subject to change without notice.

Contacts:

www.kyosemi.co.jp / info@kyosemi.co.jp

Kansai Sales Office: 949-2 Ebisu-cho, Fushimi-ku, Kyoto, 612-8201 Japan Tel: +81 75 605 7311 Fax: +81 75 605 7312 (Overseas Sales Dept.)

Tokyo Sales Office: 24th Sky Building, 2nd Floor, 1-34-3 Shinjuku, Shinjuku-ku, Tokyo 160-0022 Japan Tel: +81 3 5312 5360 Fax: +81 3 5312 5367

Eniwa Operation: 385-31 Toiso, Eniwa-shi, Hokkaido 061-1405 Japan Tel: +81 123 34 3111 Fax: +81 123 34 2110

Kyosemi Opto America Corp: 3003 Bunker Hill Lane, Suite 102, Santa Clara, CA 95054 USA Tel: +1 408 492 1486 Fax: +1 408 492 9843