

Si Photodiode

KPD151M53

Features

- Transparent epoxy mold
- High sensitivity

Applications

- Optical switches
- Optical encoders
- Pulse detectors
- Sensors and industrial controls

Dimensions (unit: mm)

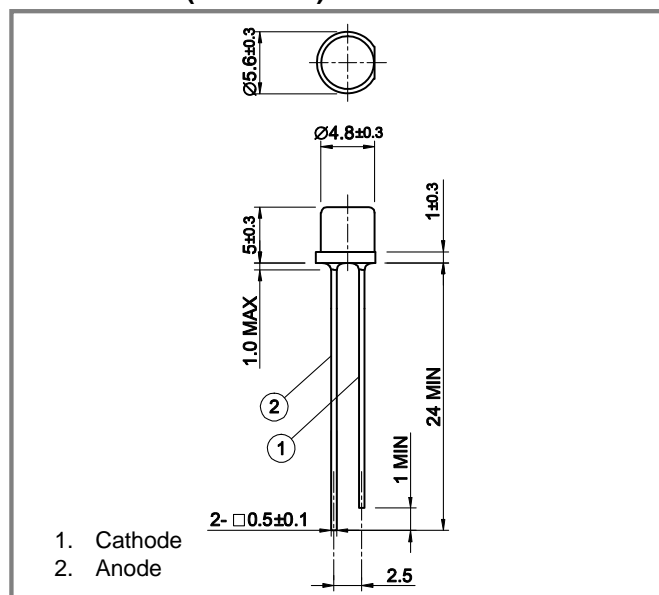

Absolute Maximum Ratings

Parameter	Symbol	Value	Unit	Note
Reverse voltage	V_R	10	V	
Reverse current	I_R	1	mA	
Forward current	I_F	10	mA	
Operating temperature	T_{opr}	-20 to +80	°C	Avoid dew condensation
Storage temperature	T_{stg}	-20 to +100	°C	Avoid dew condensation
Soldering Temperature	T_{sol}	260	°C	5sec max

Electrical and Optical Characteristics (Ta=25 °C unless otherwise noted)

Parameter	Symbol	Min.	Typ.	Max	Unit	Test Conditions
Active area	S	1.25 x 1.25			mm ²	
Operating voltage	V_{opr}	-	-	5	V	
Sensitive wavelength	λ	400	950(λ_p)	1000	nm	λ_p =Peak wavelength
Open circuit voltage	V_{op}	-	400	-	mV	1000lx @2856K
Short circuit current	I_{sh}	-	16	-	μ A	1000lx @2856K
Dark current	I_D	-	-	10	nA	V_R =5V
Terminal capacitance	C_t	-	6	-	pF	V_R =5V, f=1MHz
Half angle	2θ	-	130	-	deg	

Specifications are subject to change without notice.

Si Photodiode

KPD151M53

Dark Current - Reverse Voltage

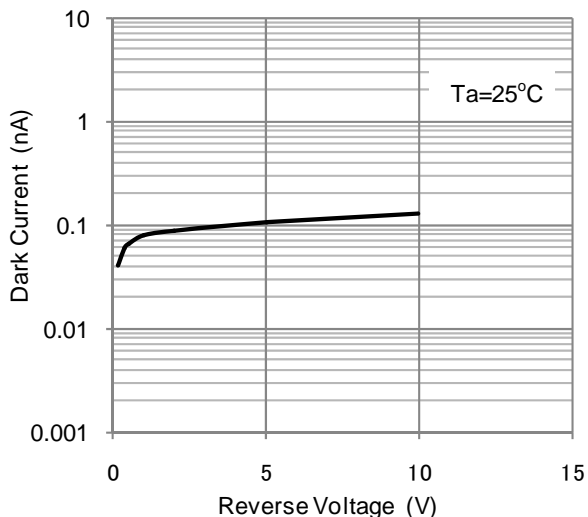

Photocurrent - Ambient Temperature

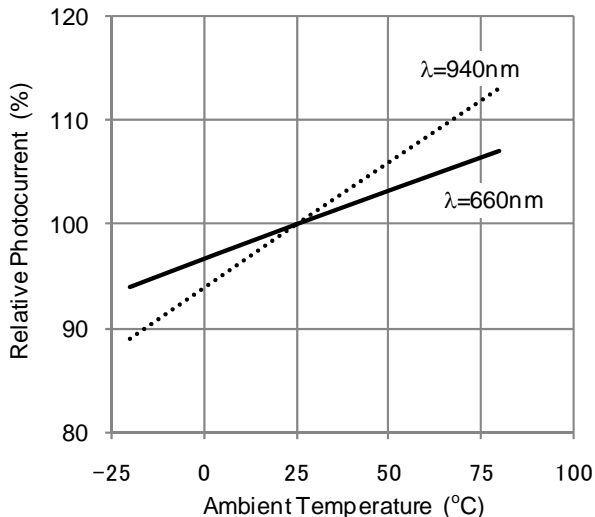

Photocurrent - Illuminance

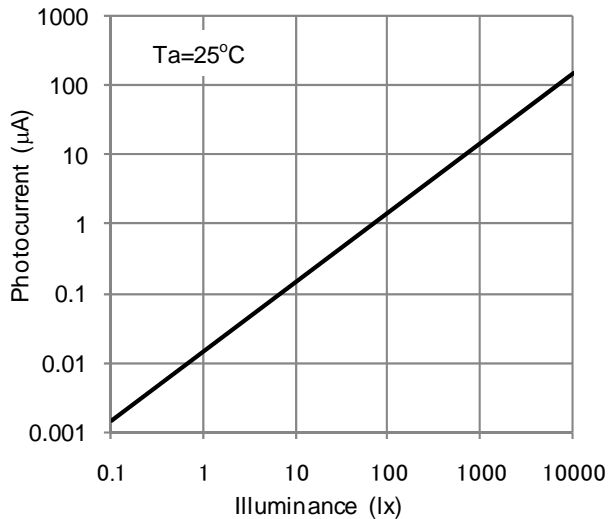

Dark Current - Ambient Temperature

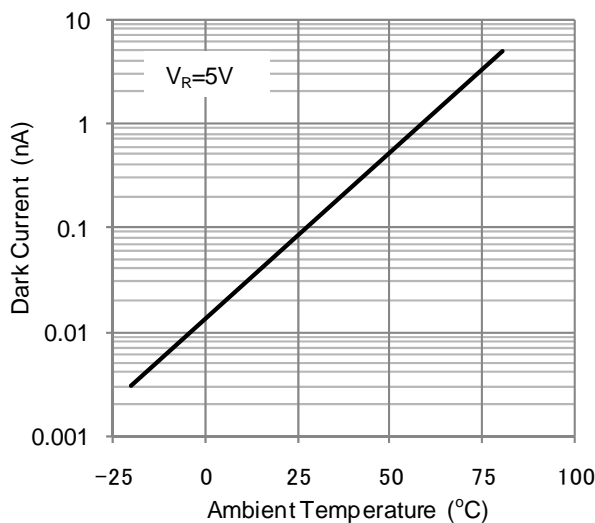

Spectral Responsivity

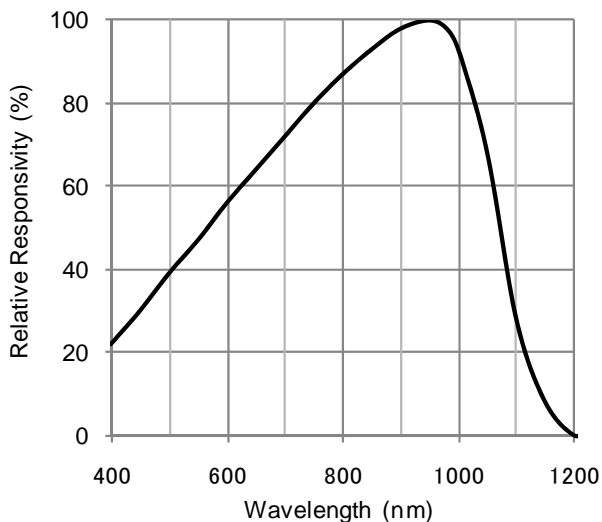

Directivity

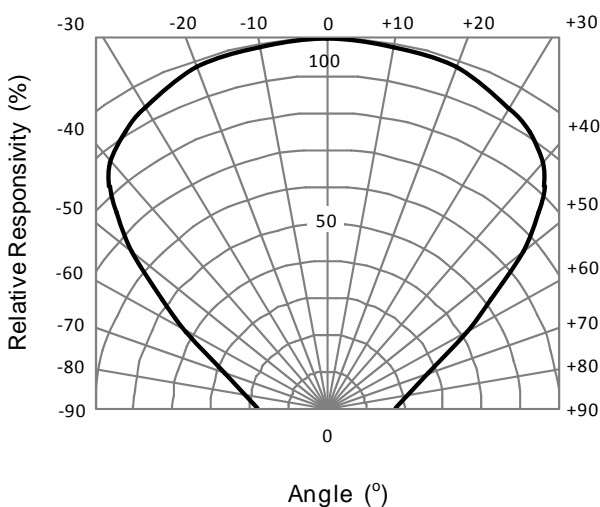

Specifications are subject to change without notice.

Contacts:

www.kyosemi.co.jp / info@kyosemi.co.jp

Kansai Sales Office: 949-2 Ebisu-cho, Fushimi-ku, Kyoto, 612-8201 Japan Tel: +81 75 605 7311 Fax: +81 75 605 7312 (Overseas Sales Dept.)

Tokyo Sales Office: 24th Sky Building, 2nd Floor, 1-34-3 Shinjuku, Shinjuku-ku, Tokyo 160-0022 Japan Tel: +81 3 5312 5360 Fax: +81 3 5312 5367

Eniwa Operation: 385-31 Toiso, Eniwa-shi, Hokkaido 061-1405 Japan Tel: +81 123 34 3111 Fax: +81 123 34 2110

Kyosemi Opto America Corp: 3003 Bunker Hill Lane, Suite 102, Santa Clara, CA 95054 USA Tel: +1 408 492 1486 Fax: +1 408 492 9843