

Si Photodiode

KPD1803H

Features

- Hermetic seal type for high reliability uses
- Flat-glass window

Applications

- Optical switches
- Optical encoders
- Pulse detectors
- Sensors and industrial controls

Dimensions (unit: mm)

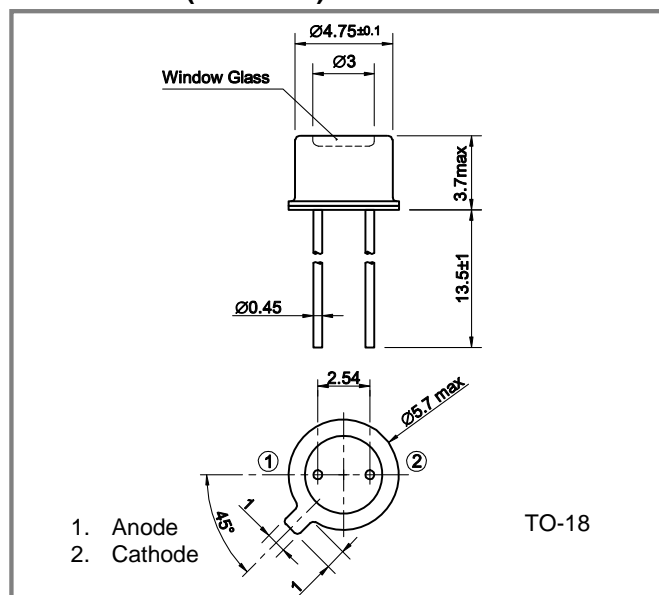

Absolute Maximum Ratings

Parameter	Symbol	Value	Unit	Note
Reverse voltage	V_R	10	V	
Reverse current	I_R	500	μA	
Forward current	I_F	10	mA	
Operating temperature	T_{opr}	-40 to +125	$^{\circ}C$	Avoid dew condensation
Storage temperature	T_{stg}	-55 to +125	$^{\circ}C$	Avoid dew condensation

Electrical and Optical Characteristics (Ta=25 °C unless otherwise noted)

Parameter	Symbol	Min.	Typ.	Max	Unit	Test Conditions
Active area	S	1.5 x 1.8			mm^2	
Operating voltage	V_{opr}	-	-	5	V	
Sensitive wavelength	λ	400	840(λ_p)	1000	nm	λ_p =Peak wavelength
Open circuit voltage	V_{op}	-	450	-	mV	1000lx @2856K
Short circuit current	I_{sh}	-	17	-	μA	1000lx @2856K
Dark current	I_D	-	-	1	nA	$V_R=5V$
Terminal capacitance	C_t	-	250	-	pF	$V_R=0V, f=1MHz$

Specifications are subject to change without notice.

Dark Current - Reverse Voltage

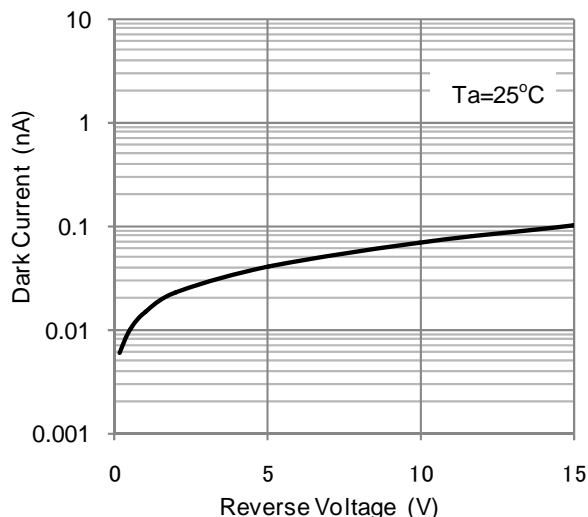

Photocurrent - Ambient Temperature

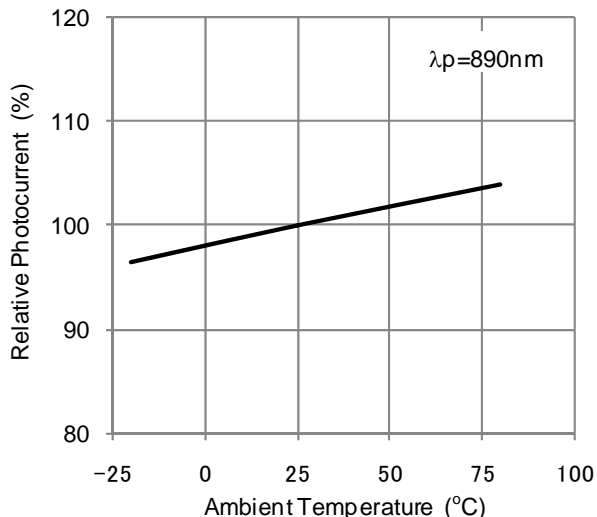

Photocurrent - Illuminance

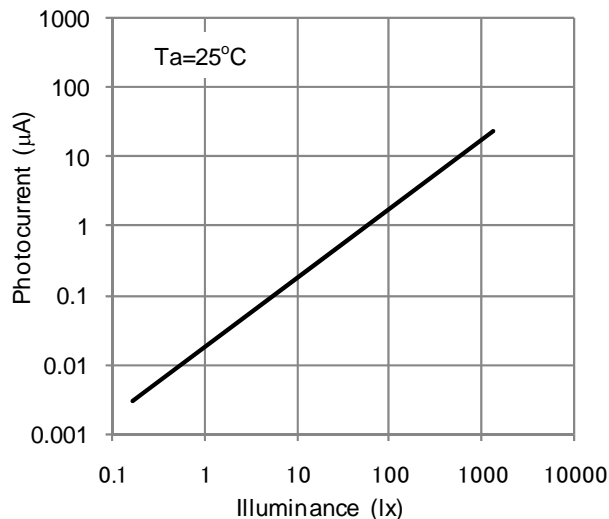

Dark Current - Ambient Temperature

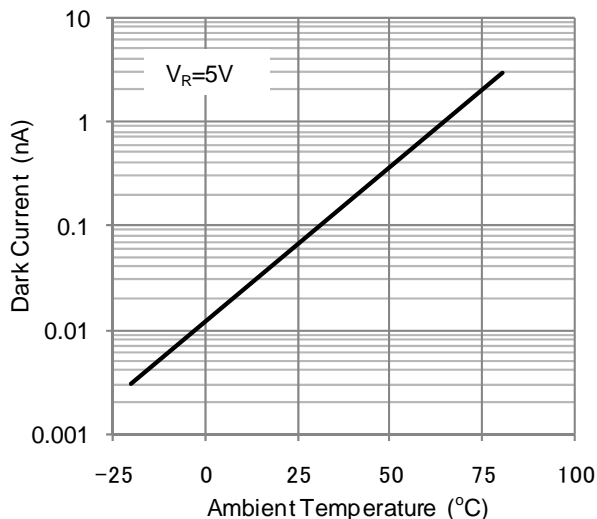

Spectral Responsivity

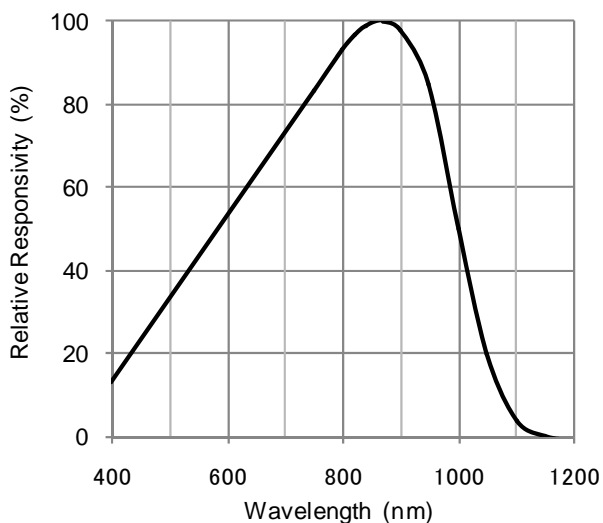

Directivity

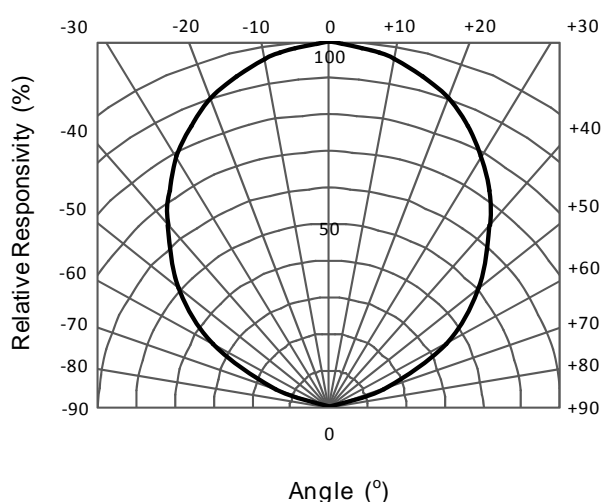

Specifications are subject to change without notice.

Contacts:

www.kyosemi.co.jp / info@kyosemi.co.jp

Kansai Sales Office: 949-2 Ebisu-cho, Fushimi-ku, Kyoto, 612-8201 Japan Tel: +81 75 605 7311 Fax: +81 75 605 7312 (Overseas Sales Dept.)

Tokyo Sales Office: 24th Sky Building, 2nd Floor, 1-34-3 Shinjuku, Shinjuku-ku, Tokyo 160-0022 Japan Tel: +81 3 5312 5360 Fax: +81 3 5312 5367

Eniwa Operation: 385-31 Toiso, Eniwa-shi, Hokkaido 061-1405 Japan Tel: +81 123 34 3111 Fax: +81 123 34 2110

Kyosemi Opto America Corp: 3003 Bunker Hill Lane, Suite 102, Santa Clara, CA 95054 USA Tel: +1 408 492 1486 Fax: +1 408 492 9843