

# Si Photodiode

# KPD31S

### Features

- Transparent epoxy mold
- High sensitivity

### Applications

- Optical switches
- Optical encoders
- Pulse detectors
- Sensors and industrial controls

### Dimensions (unit: mm)

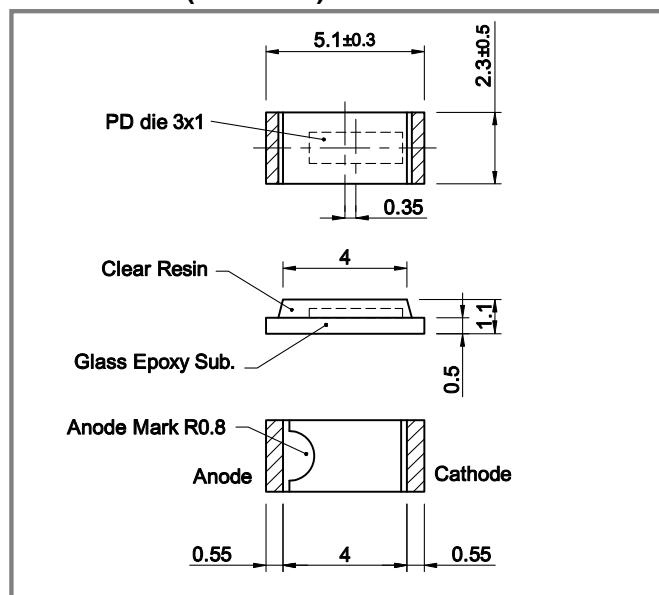

### Absolute Maximum Ratings

Parameter	Symbol	Value	Unit	Note
Reverse voltage	$V_R$	10	V	
Forward current	$I_F$	3	mA	
Operating temperature	$T_{opr}$	-25 to +80	°C	Avoid dew condensation
Storage temperature	$T_{stg}$	-25 to +85	°C	Avoid dew condensation
Soldering Temperature	$T_{sol}$	260	°C	5sec max

### Electrical and Optical Characteristics (Ta=25 °C unless otherwise noted)

Parameter	Symbol	Min.	Typ.	Max	Unit	Test Conditions
Active area	S	2.8 x 0.8			mm <sup>2</sup>	
Operating voltage	$V_{opr}$	-	-	5	V	
Sensitive wavelength	$\lambda$	400	950( $\lambda_p$ )	1000	nm	$\lambda_p$ =Peak wavelength
Open circuit voltage	$V_{op}$	-	350	-	mV	1000lx @2856K
Short circuit current	$I_{sh}$	-	22	-	$\mu$ A	1000lx @2856K
Dark current	$I_D$	-	-	10	nA	$V_R=5V$
Terminal capacitance	$C_t$	-	7	-	pF	$V_R=5V, f=1MHz$

Specifications are subject to change without notice.

**Dark Current - Reverse Voltage**

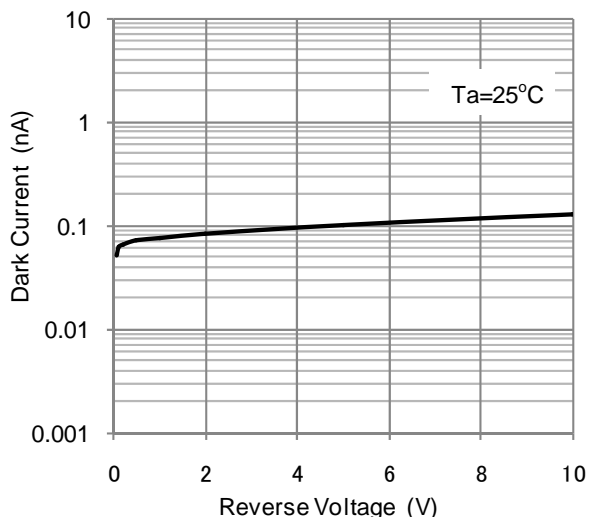

**Photocurrent - Ambient Temperature**

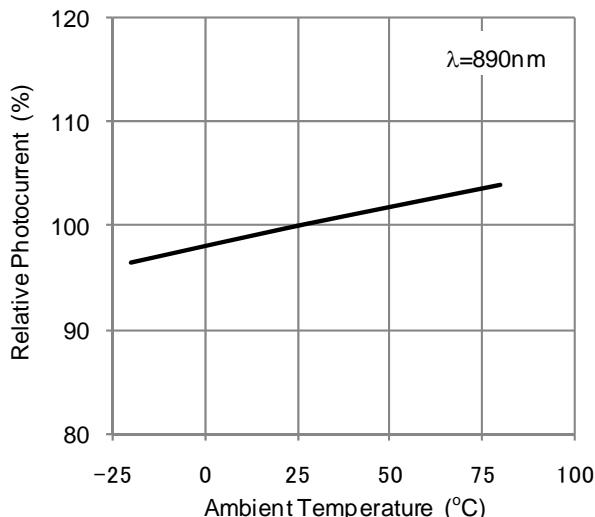

**Photocurrent - Illuminance**

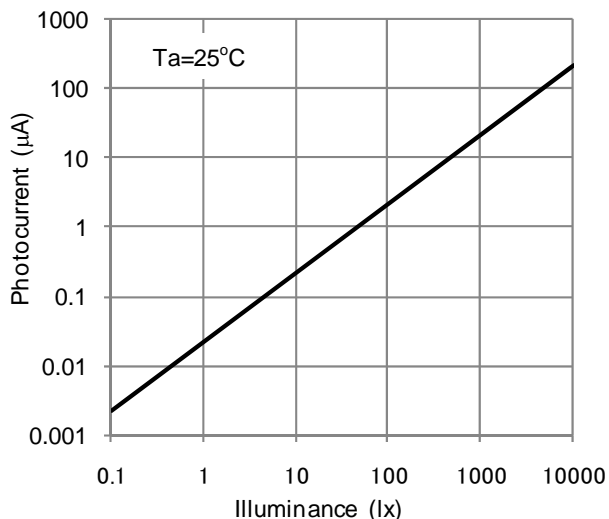

**Dark Current - Ambient Temperature**

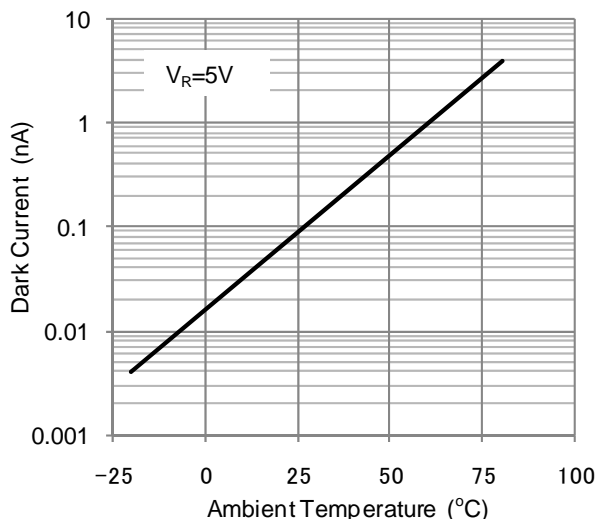

**Spectral Responsivity**

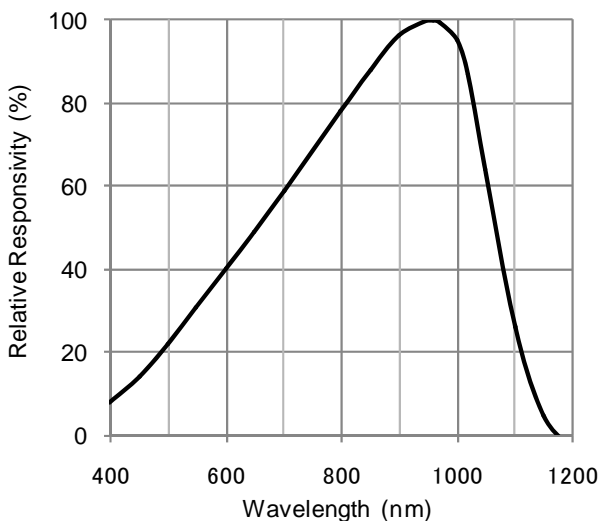

**Directivity**

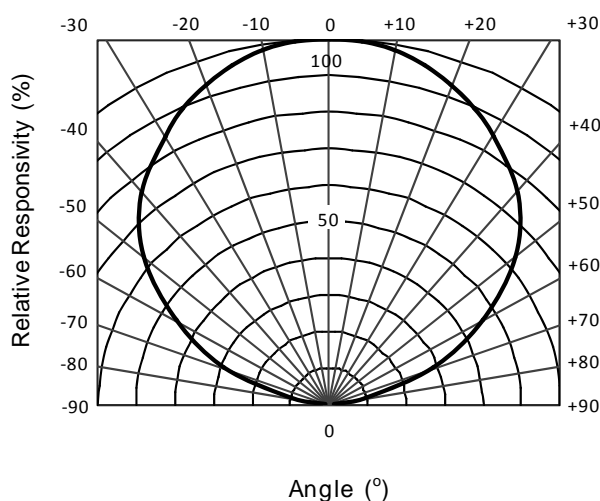

Specifications are subject to change without notice.

**Contacts:**

[www.kyosemi.co.jp](http://www.kyosemi.co.jp) / [info@kyosemi.co.jp](mailto:info@kyosemi.co.jp)

Kansai Sales Office: 949-2 Ebisu-cho, Fushimi-ku, Kyoto, 612-8201 Japan Tel: +81 75 605 7311 Fax: +81 75 605 7312 (Overseas Sales Dept.)

Tokyo Sales Office: 24th Sky Building, 2nd Floor, 1-34-3 Shinjuku, Shinjuku-ku, Tokyo 160-0022 Japan Tel: +81 3 5312 5360 Fax: +81 3 5312 5367

Eniwa Operation: 385-31 Toiso, Eniwa-shi, Hokkaido 061-1405 Japan Tel: +81 123 34 3111 Fax: +81 123 34 2110

Kyosemi Opto America Corp: 3003 Bunker Hill Lane, Suite 102, Santa Clara, CA 95054 USA Tel: +1 408 492 1486 Fax: +1 408 492 9843